

High performance low cost power electronics coldplates – Call for volume

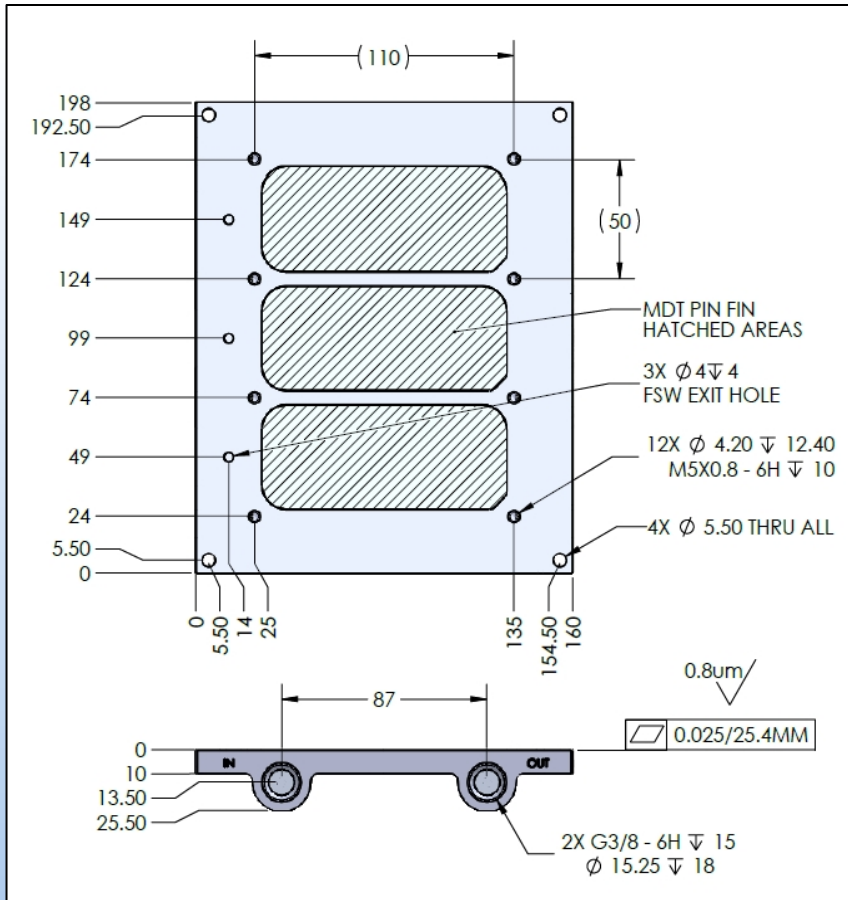
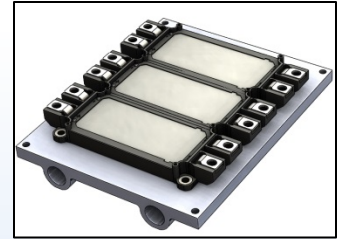

Designed to cool one 122x162mm power module

- Tub Material: Al 6061
- Fin Plate Material : Al 1100-H14
- MDT in-line pin fin inside: Choice of 12 fins per inch or XP (extra performance, 20 fins per inch)
- Pressure tested to 5bar
- Mass: 1075 gr
- G3/8 (BSPP) ports
- Compatible with most coolants: ethylene glycol, propylene glycol, water, Opticool, Dowfrost, Dowtherm, Dynalene, 3M Novec

Custom Options

- Length: Extrusion length can change to accommodate up to 3 IGBTs
- Ports: NPT/SAE/BSPP (G)
- Plating options: Electroless Nickel inside and out available
- Go to [MicroCooling.com](http://MicroCooling.com) to see all options.

Thermal Resistance (C/W)

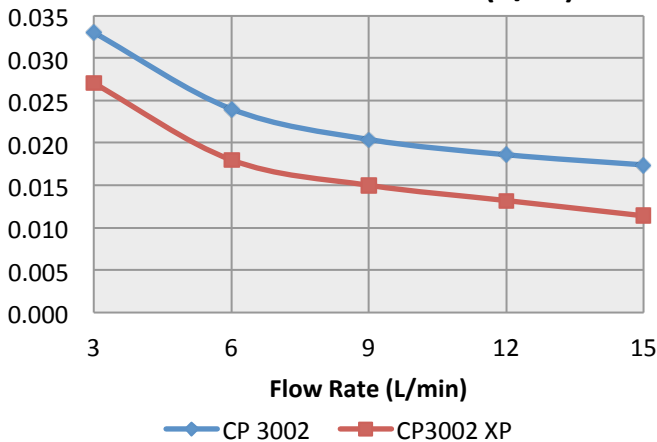

Pressure Drop (bar)

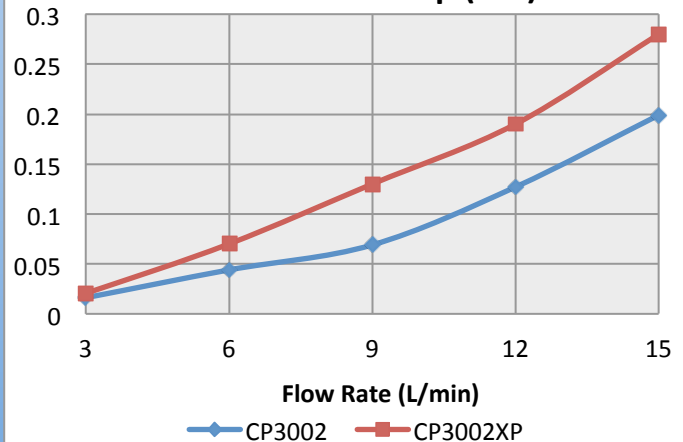

Thermal resistance calculated as the difference between the maximum coldplate surface temp. and the fluid Inlet temp. Fluid: 50/50 Ethylene Glycol & Water. Pressure Drop Includes G3/8 fittings. Empirically tested with 3 IGBT module sized heaters.

CP3002  
CP3002 XP  
Patent Pending

WOLVERINE  
**MICROCOOL**<sup>®</sup>  
ENGINEERING THERMAL INNOVATION

MicroCool<sup>®</sup> liquid cooled coldplates are designed to fit common IGBT and Power electronics configurations used today. At the heart of each MicroCool<sup>®</sup> cold plate is our patented Micro Deformation Technology (MDT<sup>™</sup>) in line pin fin, Friction Stir Welded construction, and CFD optimized parallel cooling. The 3000 Series coldplates feature MicroCool's library of extruded tubs / manifolds, allowing for the best performing and lowest cost coldplate on the market today.

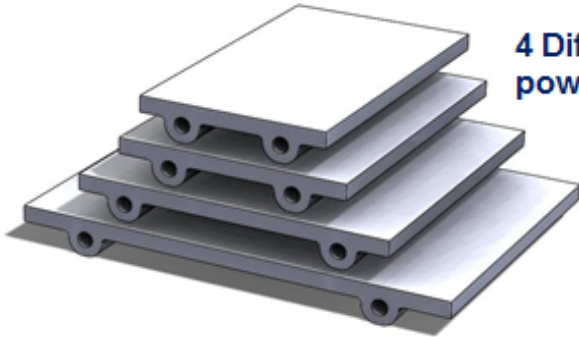

4 Different aluminum extrusion sizes to fit 90% of the power modules on the market today.

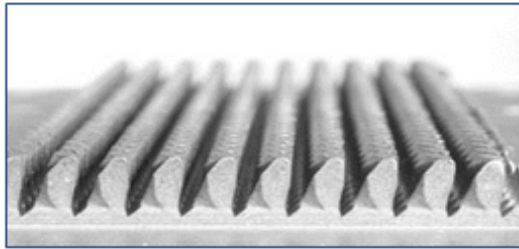

**MDT<sup>®</sup> Pin Plate Options**  
(AL 1100-H14: 220 W/m-K)

- 4mm tall 12 fins/inch inline pin (1mm dia/gap)
- XP 4mm tall 20 fins/inch inline pin (.5mm dia/gap)

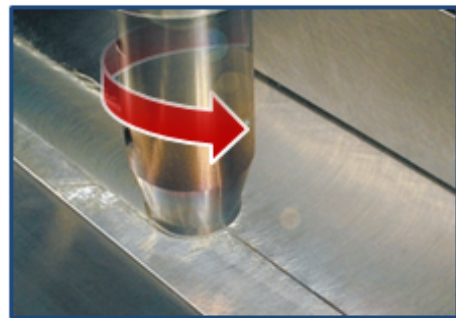
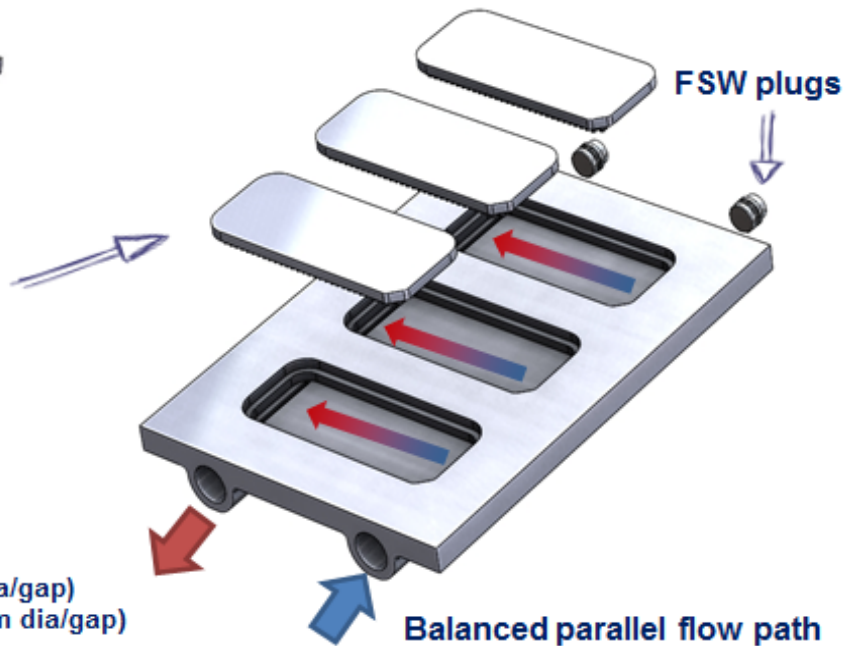

**Friction stir welded construction**

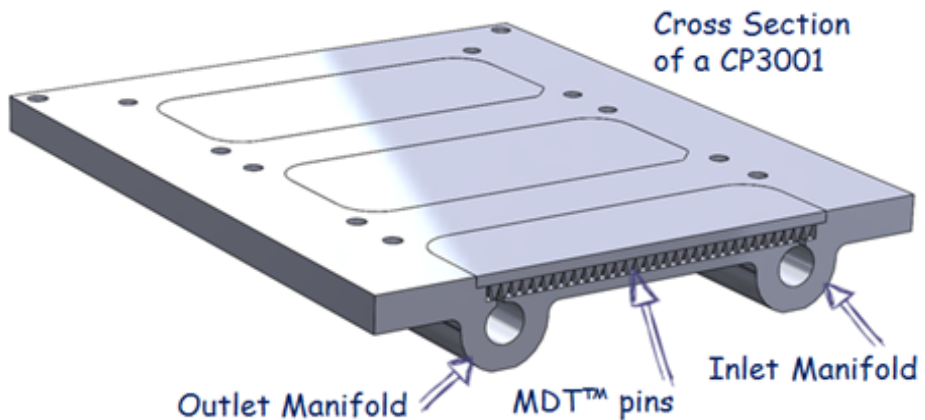

Cross Section of a CP3001

Outlet Manifold

MDT<sup>™</sup> pins

Inlet Manifold